

Response Time Analysis of Multiframe Mixed-Criticality Systems

Ishfaq Hussain*, Muhammad Ali Awan, Pedro F. Souto,
Konstantinos Bletsas, Benny Akesson, Eduardo Tovar



Outline

Motivation

Contribution

Background

System model

Proposed analyses

Evaluation

Conclusions and future work

Motivation

- Many real-time embedded domains favor mixed-criticality systems.
- Static and adaptive variant of Vestal's improves the processor use efficiency.
- Pessimistic when the WCET of successive instances vary greatly.
- Leverage the known variability in execution time for even more efficiency.

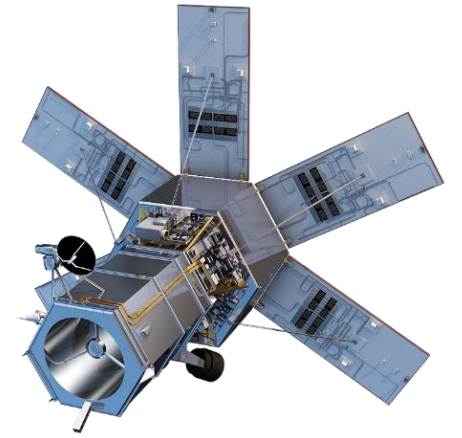

Main contributions

Multiframe Vestal model

Schedulability analyses for
multiframe mixed-criticality systems

Extensive experiments and
comparison with frame-agnostic
analysis

Background: Static mixed-criticality model

- Multiple WCET estimates per task with corresponding degree of confidence.
- The WCET of all the tasks is monitored using Watchdog timers.
- Calculate WCRT of each task using WCETs with confidence level commensurate of analyzed task's criticality.

Background: Adaptive mixed-criticality model

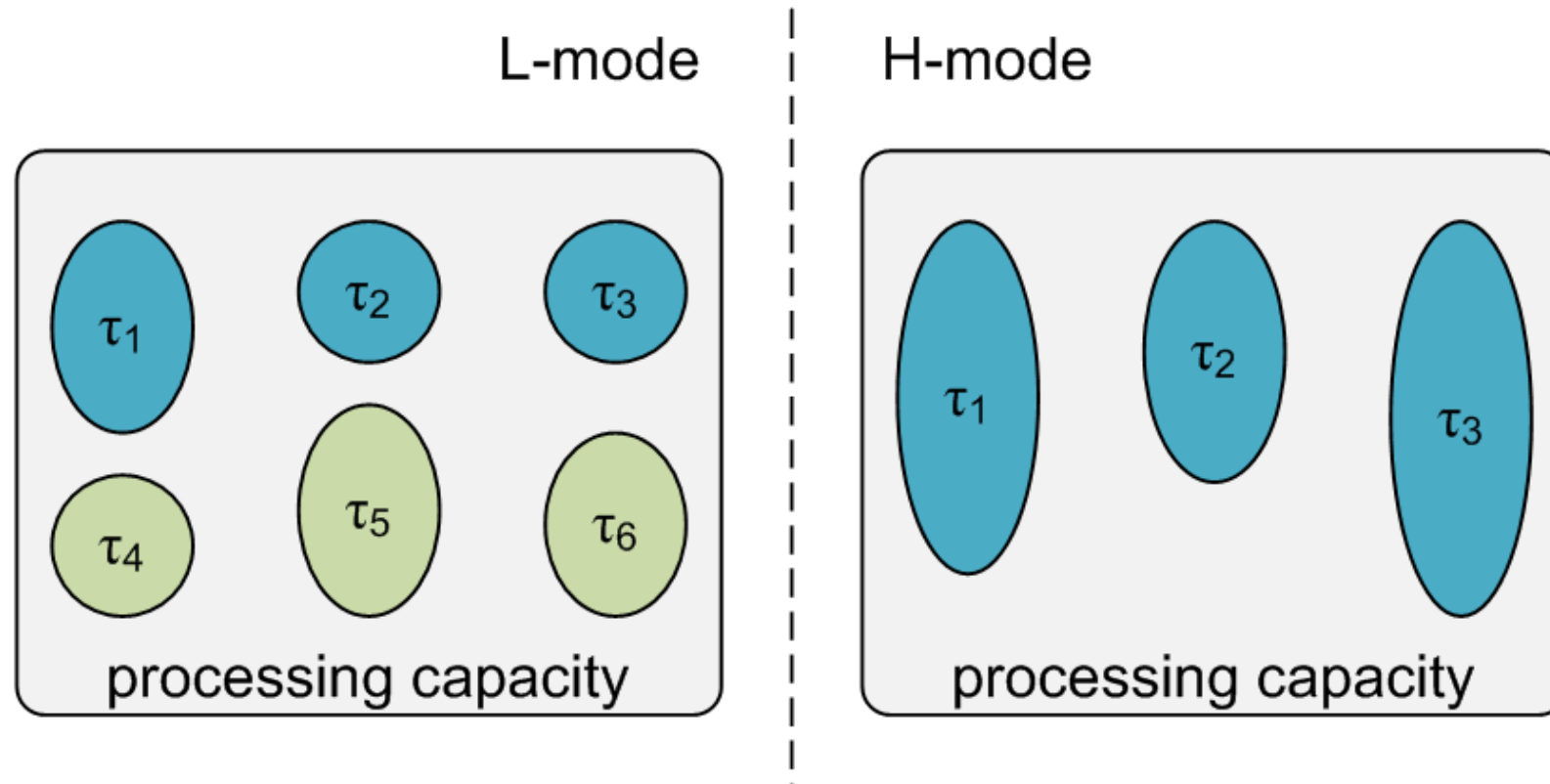

Background: Multiframe task model

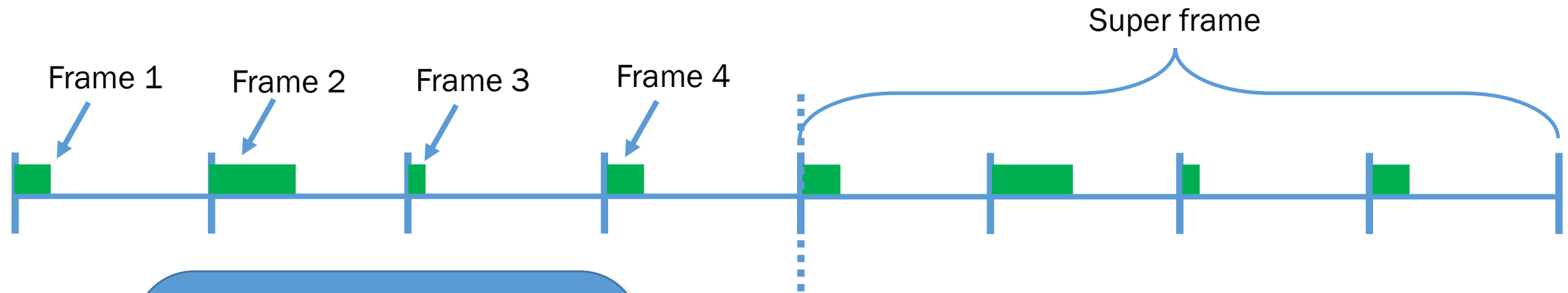

Multiframe task model

Independent
multiframe sporadic
tasks

Mixed-criticality multiframe task model

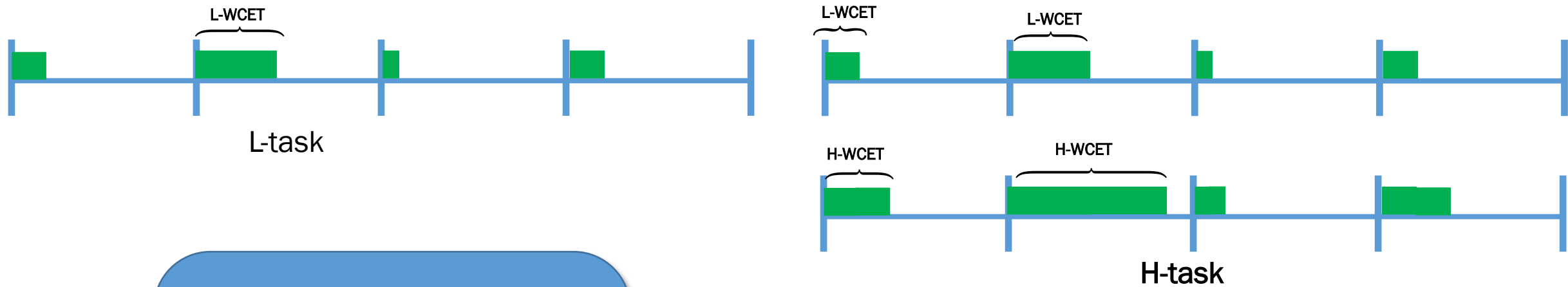

Multiframe task model

Preemptive fixed-priority scheduling

Independent multiframe sporadic tasks

Multiple WCET estimates per frame

Static multiframe MC

High Criticality Task: τ_2 and τ_3
 Low Criticality Task: τ_1

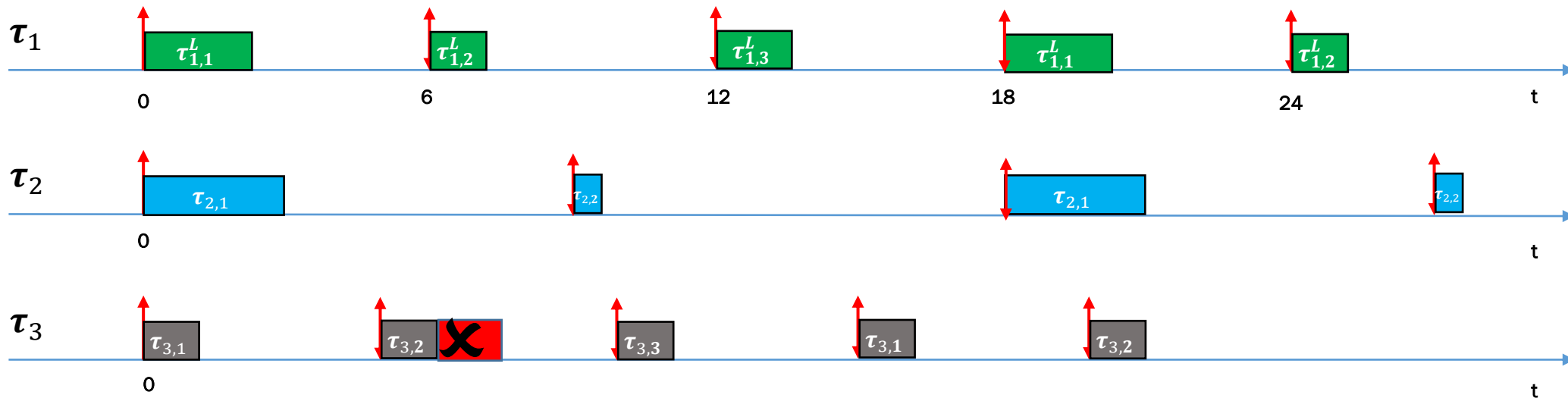

Schedulability
 Analysis

No L-task misses its deadline as long as all the tasks execute up to $C_{i,j}^L$
 No H-task misses its deadline as long as all the tasks execute up to $C_{i,j}^{k_i}$

Adaptive multiframe MC

High Criticality Task: τ_2 and τ_3
Low Criticality Task: τ_1

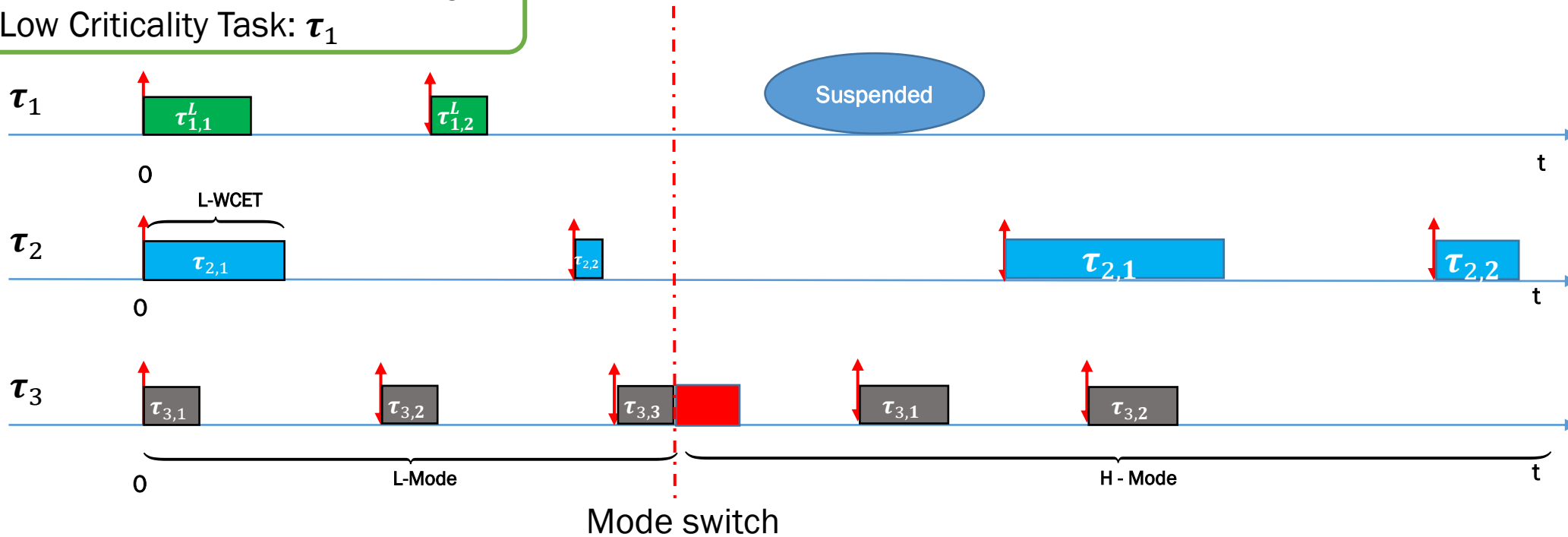

Interference by a multiframe task

$\tau_1((2,1,3), 10, 10)$

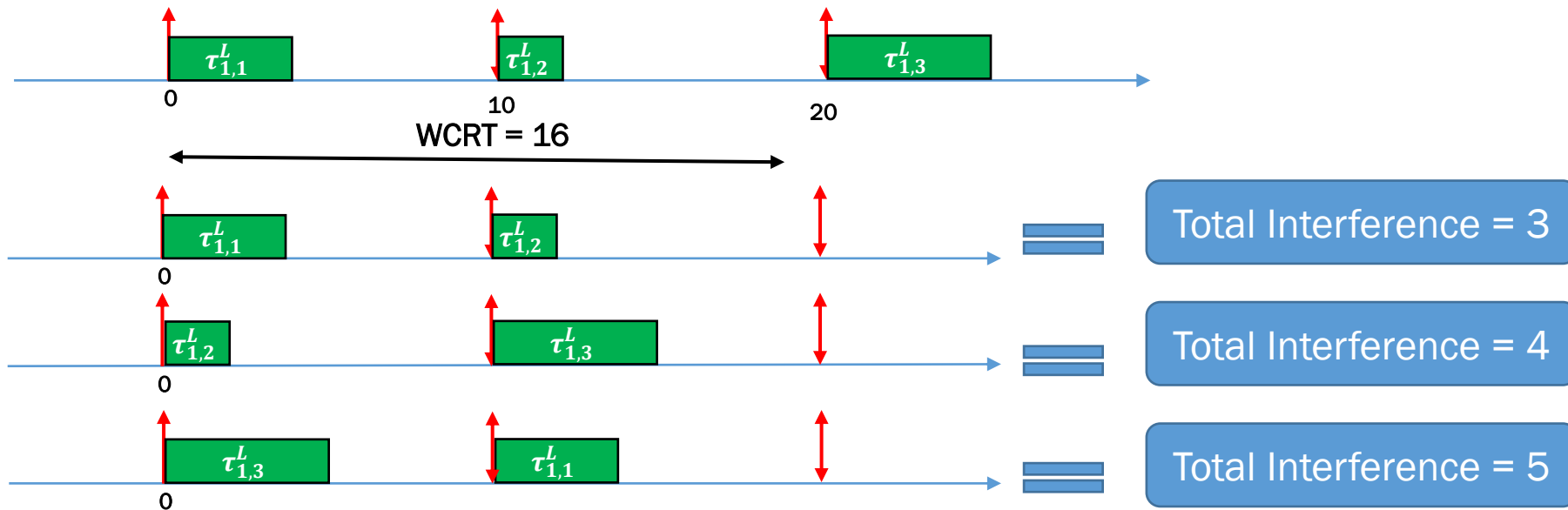

Maximum cumulative execution requirement (Baruah's approach)

Interference by a multiframe task

For two frames = $\text{Max}(a, b, c, d)$

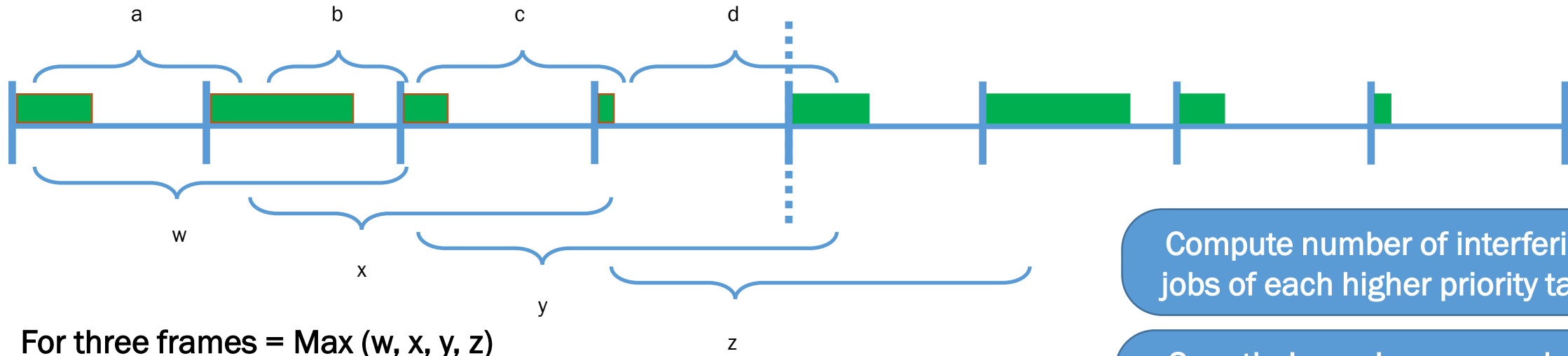

Compute number of interfering jobs of each higher priority task

Sum their maximum cumulative execution requirement

For three frames = $\text{Max}(w, x, y, z)$
 t

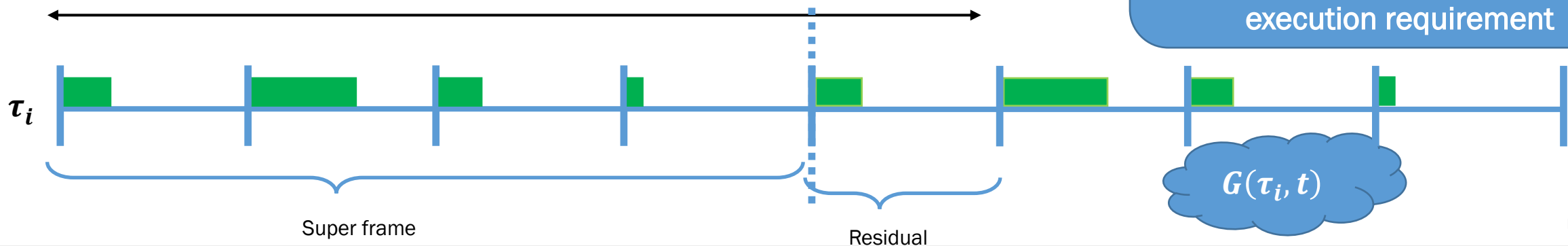

Interference by a multiframe task

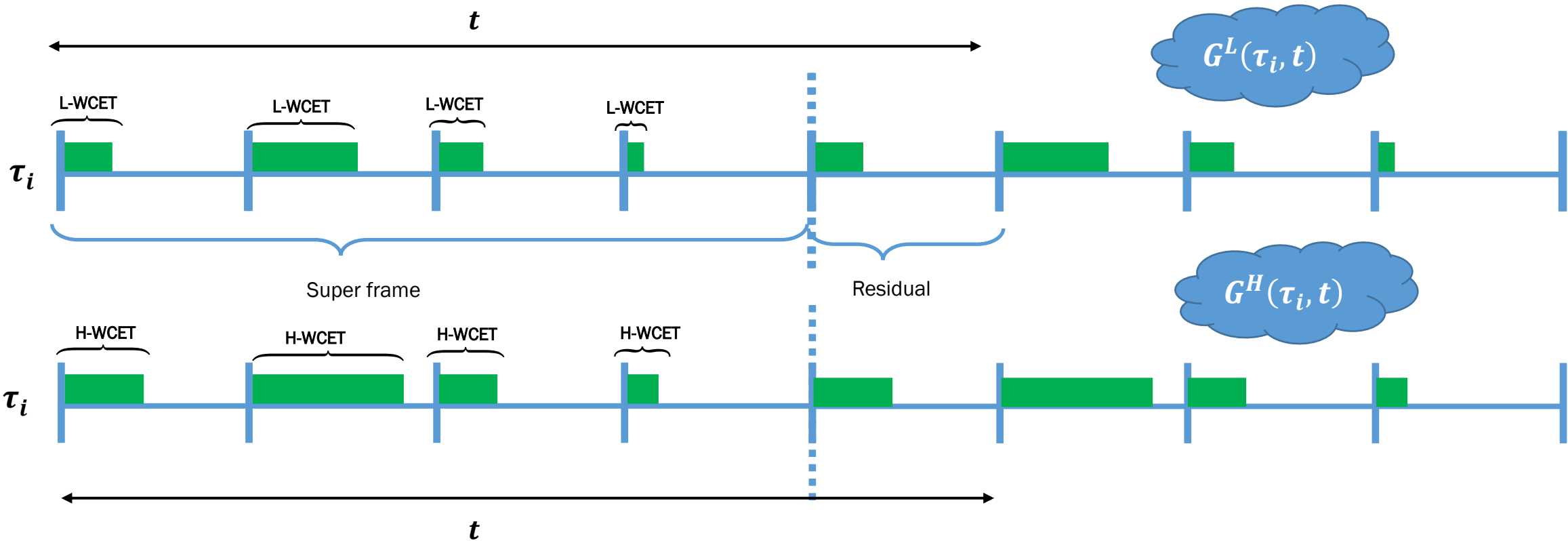

Response time analysis (SMMC)

$$R_i = C_i^H + \sum_{\tau_j \in hpL(i)} IL_j(R_i) + \sum_{\tau_k \in hpH(i)} IH_k(R_i)$$

- C_i = WCET of task under analysis
- IL_j = Interference from L-tasks
- IH_k = Interference from H-tasks

$$R_i = g^H(\tau_i, 1) + \sum_{\tau_j \in hpL(i)} G^L(\tau_j, R_i) + \sum_{\tau_k \in hpH(i)} G^H(\tau_k, R_i)$$

- WCET of task under analysis
- Interference from L-tasks
- Interference from H-tasks

Response time analysis(AMMC-rtb)

- All higher-priority **L-tasks** interfere over $[0, R_i^L)$ only; L-WCETs used.
- For higher-priority **H-tasks**, their **H-WCETs** are used.

$$R_i^* = C_i + \sum_{\tau_j \in hpL(i)} IL_j(R_i^L) + \sum_{\tau_k \in hpH(i)} IH_k(R_i^*)$$
$$R_{i,j}^* = g^H(\tau_i, 1) + \sum_{\tau_j \in hpL(i)} G^L(\tau_j, R_{i,j}^L) + \sum_{\tau_k \in hpH(i)} G^H(\tau_k, R_{i,j}^*)$$

Response time analysis (AMMC-max)

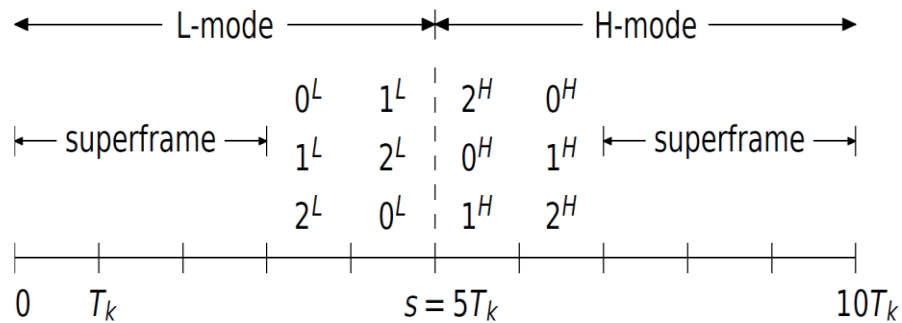

- Pessimism in A(M)MC-rtb is reduced by explicitly considering the mode change instant s .
 - L-WCETs can then be used for jobs completed in $[0, s)$.
 - Conservatively overestimating number of jobs in H-mode.
- Eliminating another source of pessimism.
 - The frame sequences before/after the mode change should “match”.
 - After frame k comes frame $(k+1) \bmod F$.

Example

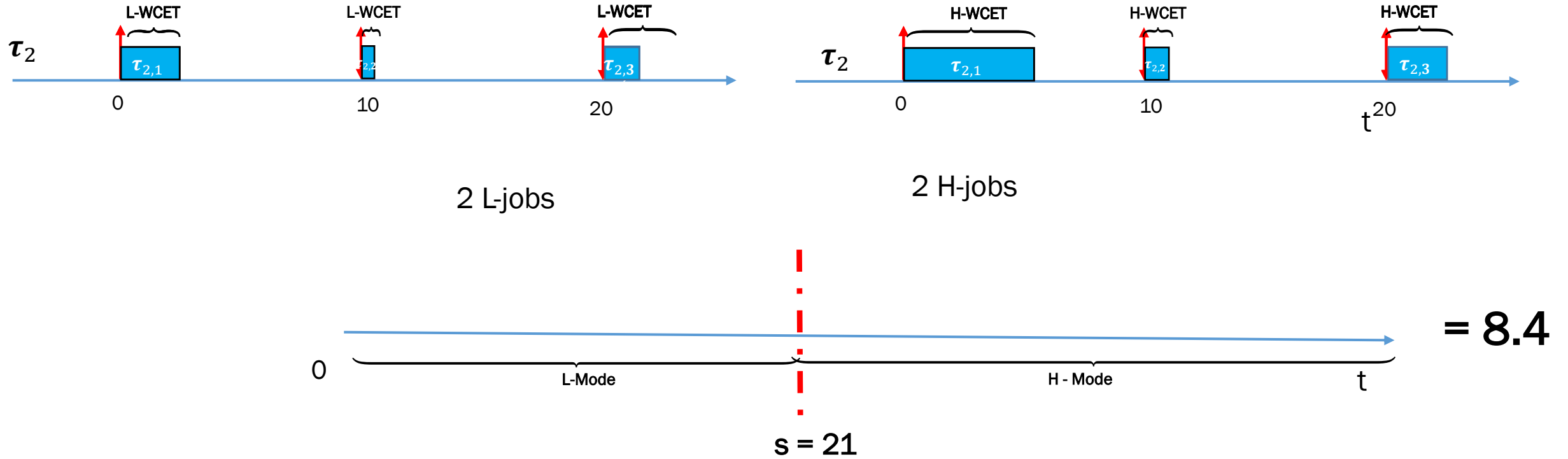

Example

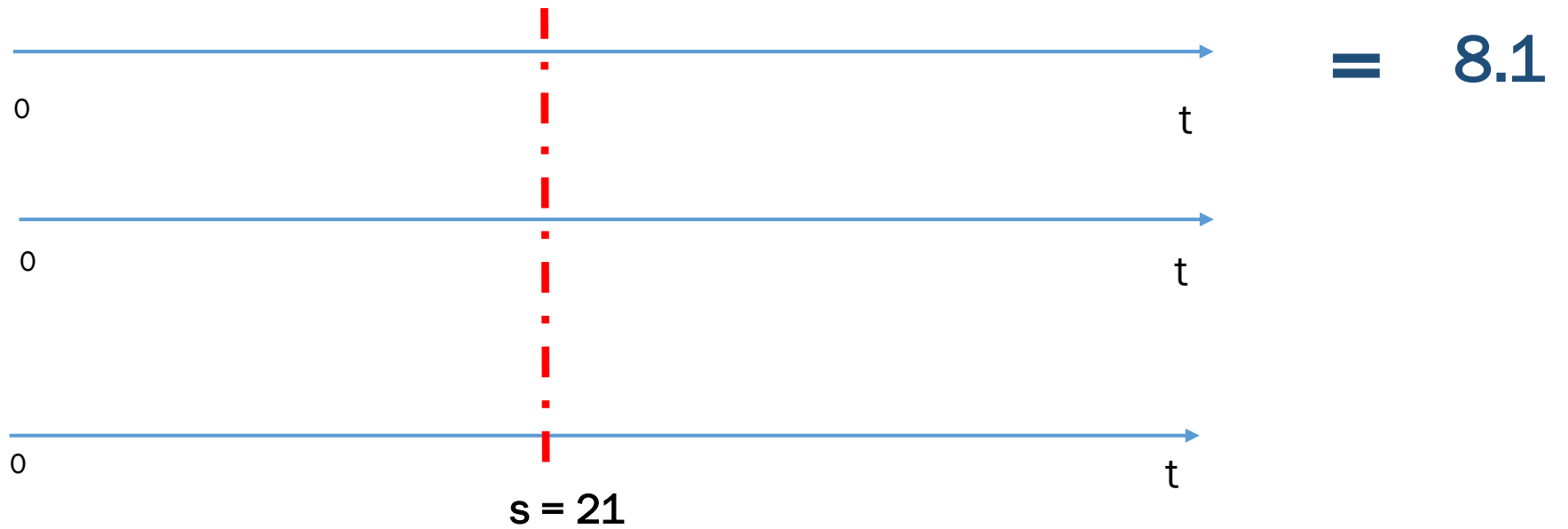
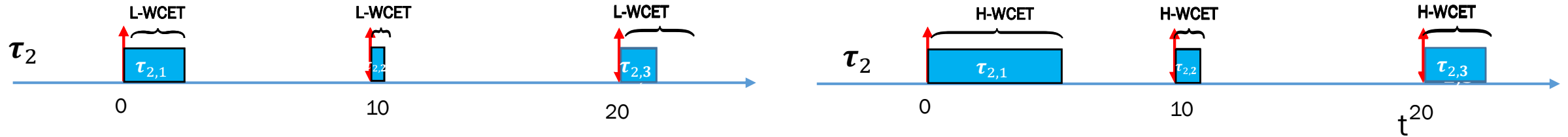

Example

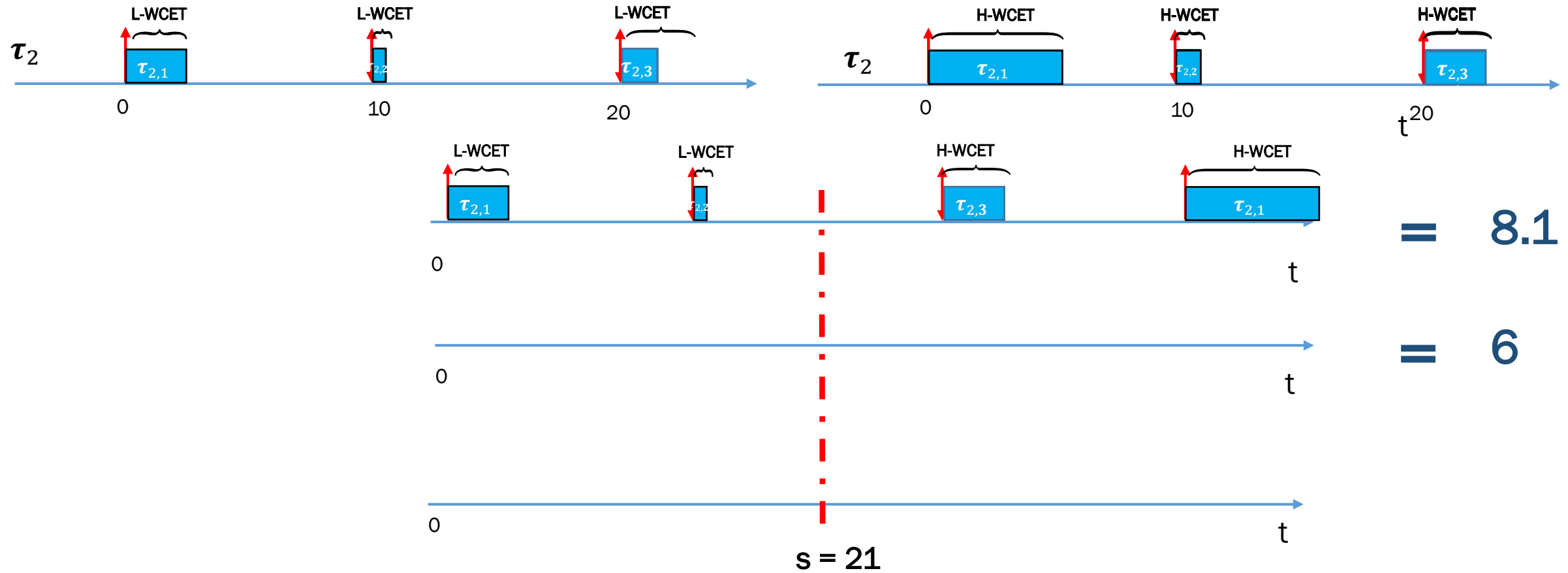

Example

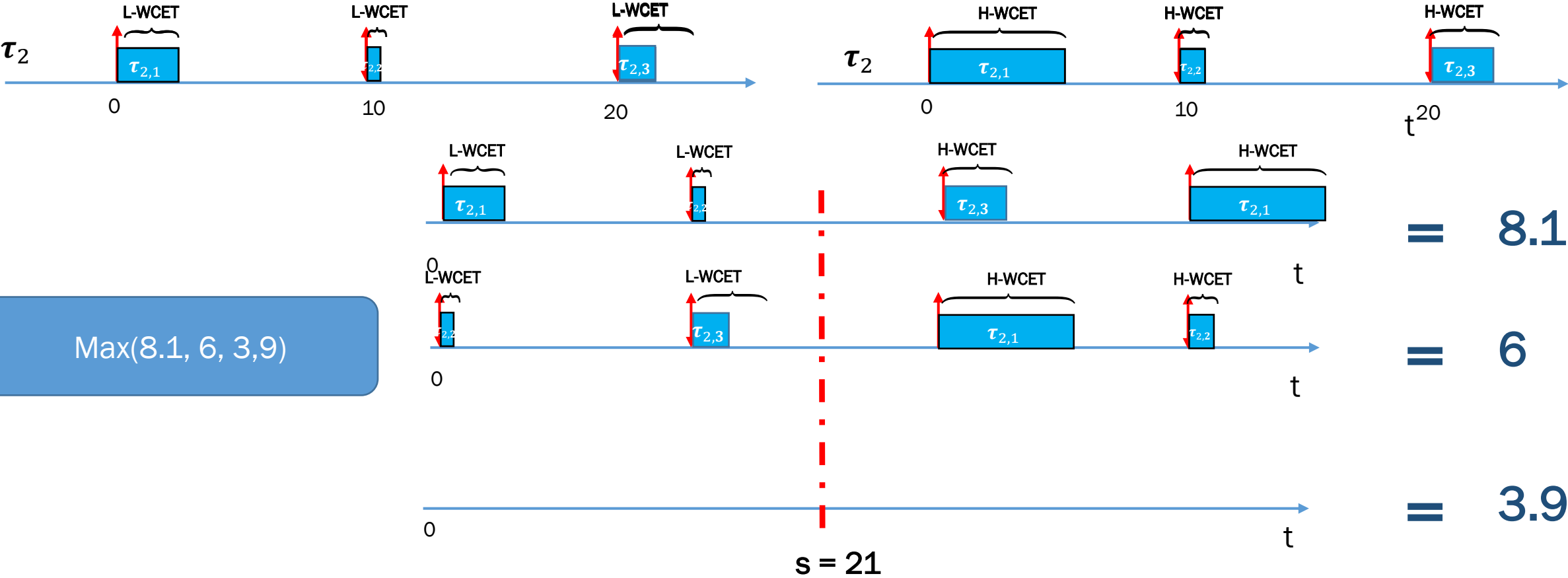

Max(8.1, 6, 3,9)

Experimental setup

- Inter-arrival time: Log-uniform distribution (10ms - 1s)
- Implicit deadlines (though algorithm works for constrained deadlines)
- L-Utilization: UUnifast-discard algorithm
- L-WCET of first frame = inter-arrival time \times L-Utilization
- Number of frames: Selected randomly
- L-WCET of other frames
 - Randomly selected with log-uniform distribution
 - Between user defined value and L-WCET of first frame
- H-WCET estimates are derived by linearly scaling up L-WCET
- 1000 random task-sets per set point
- Audsley for priority assignment

Experimental evaluation

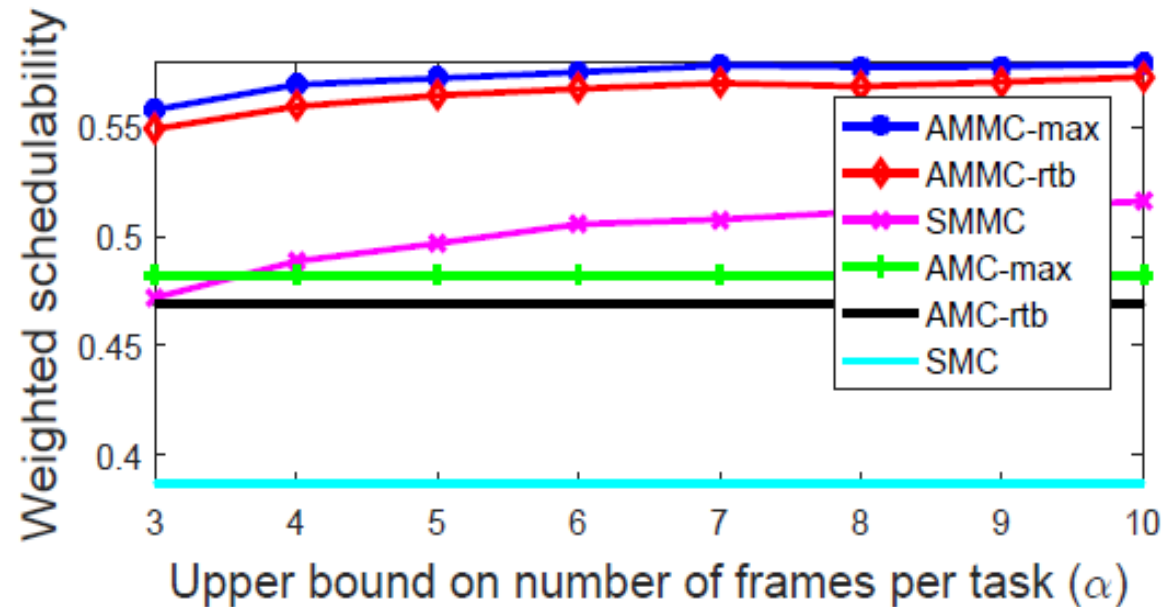
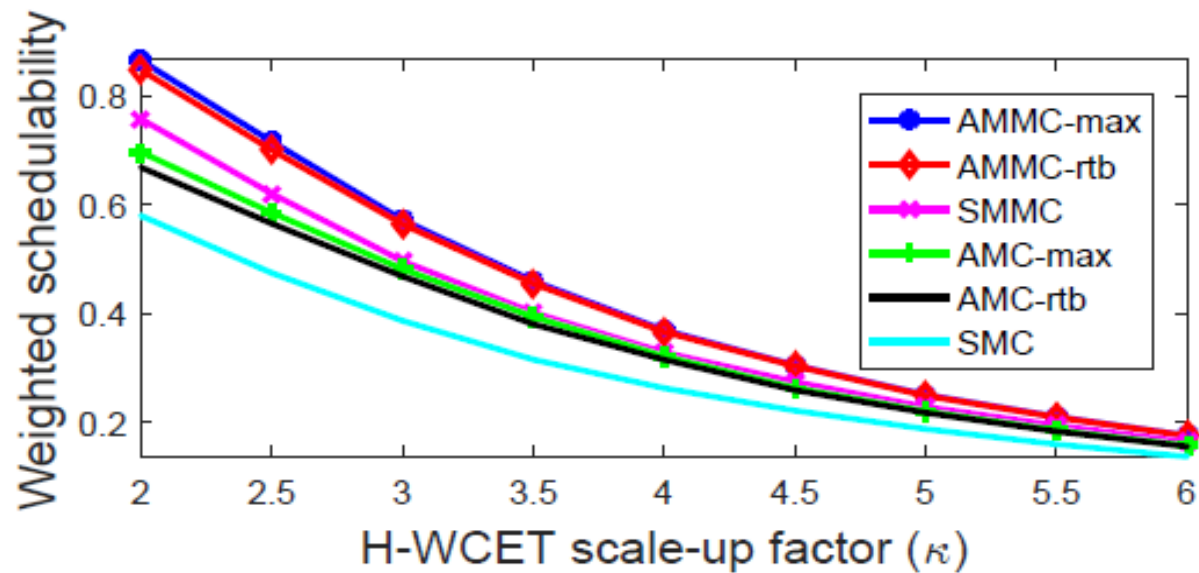

Experimental evaluation

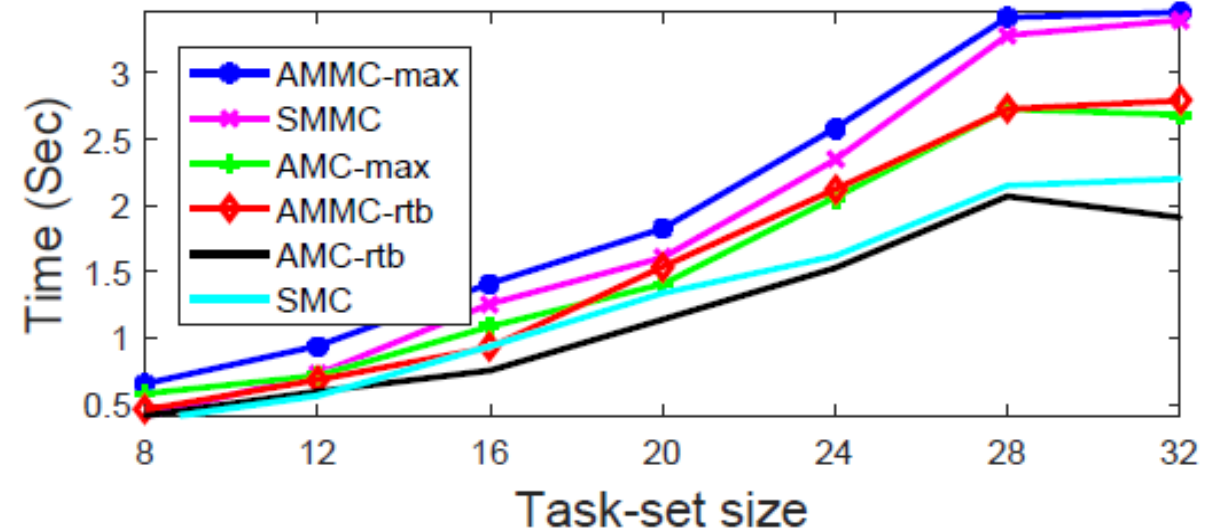
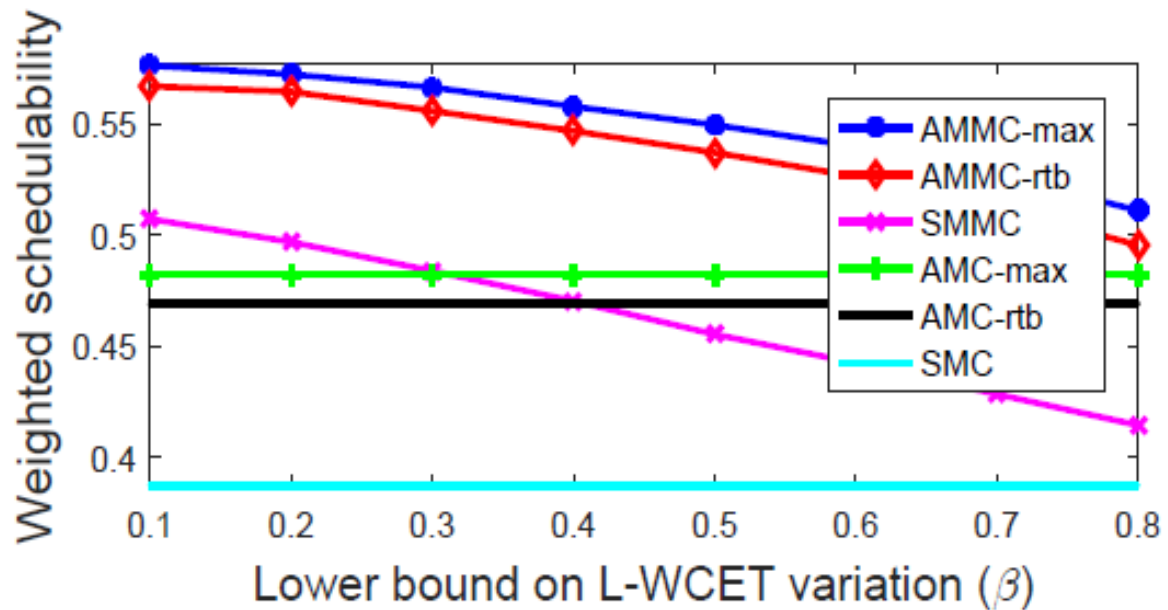

Conclusion and Future Work

> Conclusion

- > We have presented **multiframe mixed criticality model**.
- > **Schedulability analyses** for Multiframe mixed criticality systems **dominates** the single frame **counter part**.
- > Multiframe analysis are **less pessimistic** but are always **slower** compared to single frame analysis.

> Future Work

- > Incorporate the effect of **memory stalls** under **memory access regulation** into schedulability Analysis.

Thank you!

